

GATES OF JERUSALEM IN PROPHECY - PART I



Eastern Gate of Jerusalem¹

INTRODUCTION

The **Eastern Gate** of the Temple Mount is sealed off (see photo above). In the same way the mystery of the meaning of the **Gates of Jerusalem** has been sealed – until now.

The meaning is revealed to us because we are very late in the prophetic calendar before the Rapture and return of Christ. We can now look back in history and identify the prophetic meanings of the Gates precisely.

METHODOLOGY

Our method of pinpointing the dates and events for each **Gate of Jerusalem** is based on these assumptions:

1. Prophecy of the Incarnation is **Songs 6:9** (Annunciation to Mary)²
2. Prophecy of the Birth of Jesus Christ occurs in **Songs 6:10** (Gloria in Excelsis Deo)³
3. Prophecy of the life of Jesus Christ continues in Songs and ends at the Cross of Christ in **Songs 8:14**⁴
4. Modern history is predicted consecutively on a one-verse-one year basis in Songs, Isaiah and Jeremiah⁵
5. The 8th year in the life of Jesus Christ is marked as **1 AD (Isaiah 1:1 = Songs 7:4)**⁶
6. The years prophesied in Jeremiah follow consecutively after the years prophesied in Isaiah
7. Every time the word 'gate' appears in **Songs, Isaiah** or **Jeremiah** it refers to a **Gate of Jerusalem**
8. Only the **Gates of Jerusalem** in the Book of Nehemiah are prophetic of the 'rebuilding' (i.e. future)

¹ The **Eastern Gate** (called the **Golden Gate** by Moslems) was sealed by Moslems in 810, reopened by Crusaders in 1102, resealed by Saladin in 1187. Finally it was opened then sealed again by Suleiman the Magnificent, in 1541 and has remained closed since.

² "**My dove, my perfect one is unique; she is the only one of her mother, choice one of her that bore her. The daughters saw her, and called her blessed; yea, the queens and the concubines praised her.**" (Songs 6:9)

³ "**Who is this who appears as the dawn, fair as the Moon, bright as the Sun, and majestic as the Stars in procession?**"

⁴ "**Come away, my love, and be thou like to a roe or to a young hart upon the mountains of spices.**" (Songs 8:14)

⁵ We provide evidence for the one-verse one-year hypothesis in our paper: [Come Away My Love](#). We provide prophecies for years in modern history on our pages: [Isaiah](#) (1-1292AD) and [Jeremiah](#) (1293AD-present).

⁶ Each year of Jesus' life corresponds to a verse in Songs and a verse in Isaiah up to his death on the Cross (**Songs 8:14 = Isaiah 1:30**)

THE BUILDING OF THE ORIGINAL WALLS OF JERUSALEM

The walls and towers of Jerusalem were built in stages:

- (1) ancient walls of the Jebusites (surrounding the area later called the **City of David**);
- (2) walls of Solomon were extended to the Temple Mount (**1 Kings 3:1**);
- (3) towers (**Corner Gate, Valley Gate, and Ophel**) were built by Uzziah (**2 Chron. 26:9**);
- (4) the '**High Gate**' of the Temple was built by Jotham (**2 Chron. 27:3**);
- (5) walls were built by Hezekiah outside the terraces of the **City of David** to the east (**2 Chron. 32:5**);
- (6) walls were built by Hezekiah to the west and north including the **Fish Gate** (**2 Chron. 33:14**).

The map below is from a 1912 Book for Travelers. The walls called 'Present Town Wall' a heavy black line surround the area called 'Bezetha' are the modern walls of Jerusalem. These were built *after* Nehemiah.

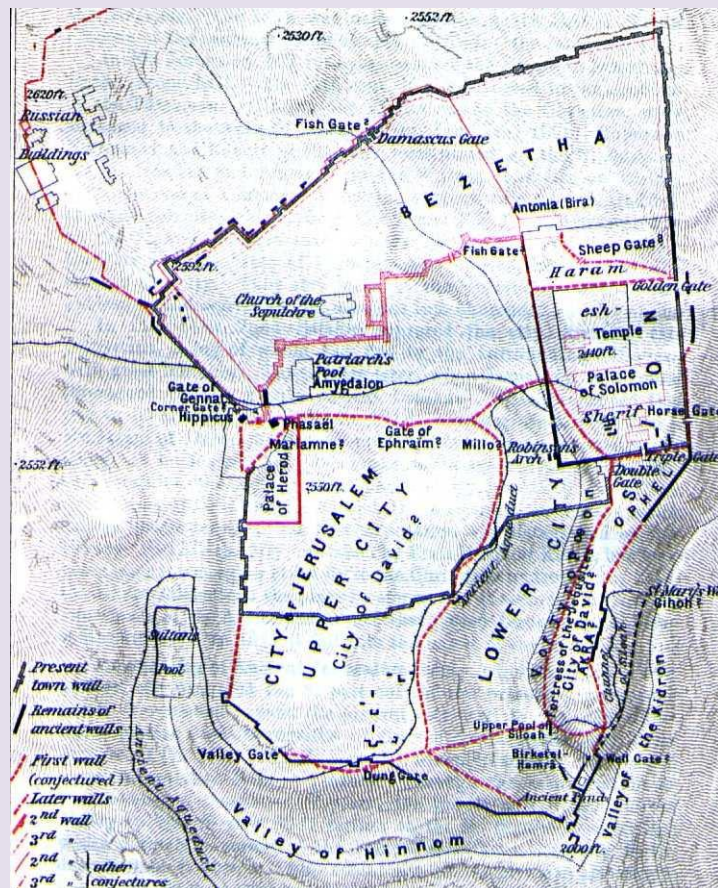

On the north side the old walls are colored in solid red, just beneath 'Bezetha'. The old **Sheep Gate** and the old **Fish Gate** can be seen here. The old **Ephraim Gate** was located 400 cubits east of the old **Corner Gate**.

On the west side the old walls continue due south following the 'First Wall' dashed red line to the 'Remains of Ancient Walls' solid black line. On the south side Hezekiah's wall includes the **Valley Gate**, the **Dung Gate**, down the hill to a corner, then the **Fountain Gate** below the **City of David**.

PROPHETIC MAP OF THE WALLS AND GATES

The map below shows the order of the gates and towers referred to in the **Book of Nehemiah**. The exact location of all the gates is lost to history. The exact shape of all the walls is lost to history.

Our map is a 'prophetic map' not a 'survey map'. The main thing the Bible student needs to know is the order of the gates, not the precise distance between them. The order we have them is as described by Nehemiah.

For example, some maps put the **Dung Gate** up on the hill where the **Valley Gate** is located. Other maps put the **Dung Gate** at the bottom of the hill. We have put it half way between since we don't know.

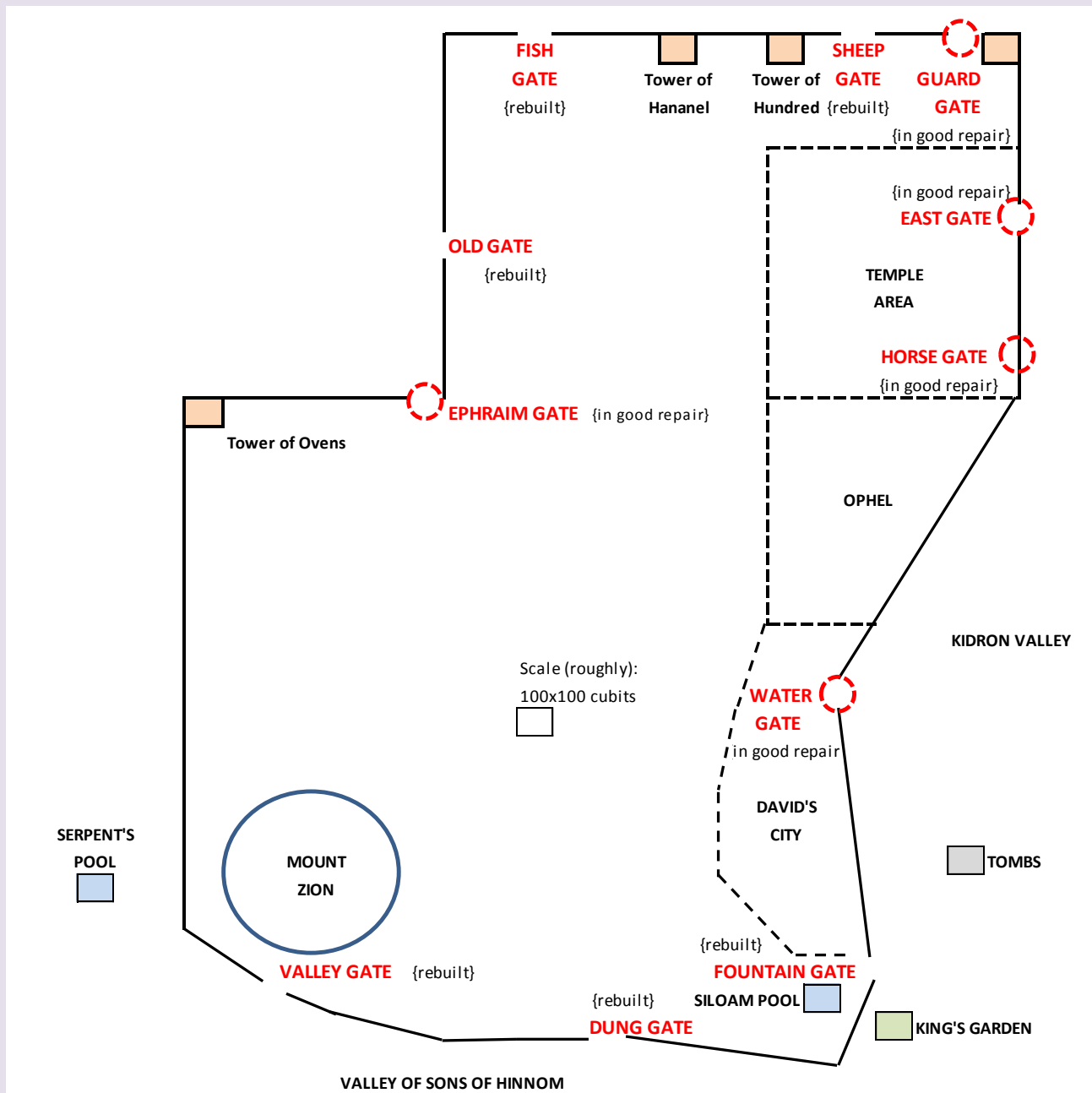

RE-BUILDING THE WALLS OF JERUSALEM (Nehemiah chapter 3)

The map below shows the families that re-built the walls. The wall is re-built starting from the **Sheep Gate** and proceeds clockwise all the way around to the beginning. This importantly tells us: prophetic fulfillment starts at the Sheep Gate, continues clock-wise, and ends at the Sheep Gate. The **Sheep Gate** is the Savior!

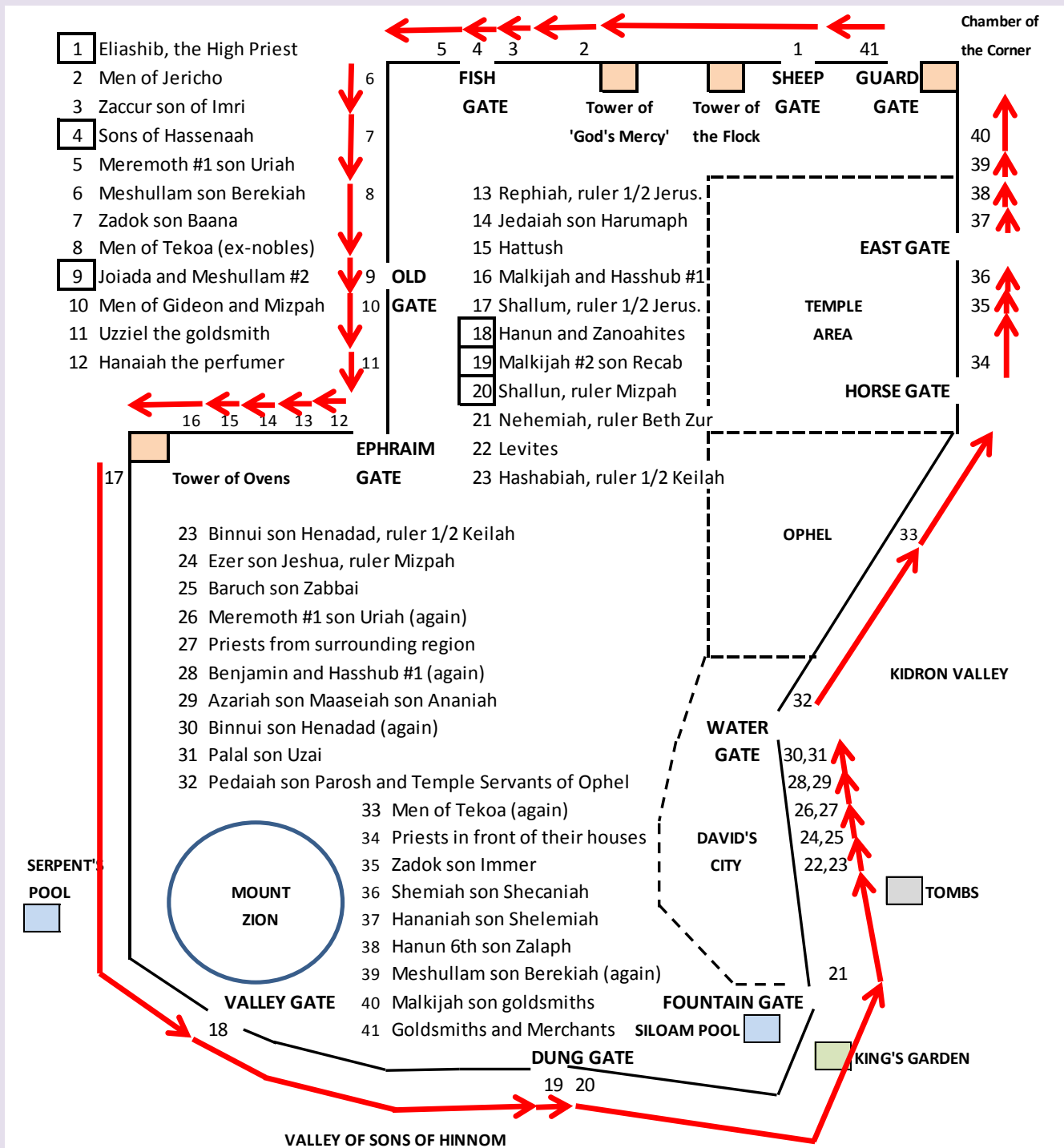

NEHEMIAH'S CHOIR TOURS (Neh. 12:27-43)

When the time came to dedicate the walls and gates of Jerusalem, Nehemiah appointed two choirs both starting at the **Valley Gate**. They walked across the walls in opposite directions to different places.

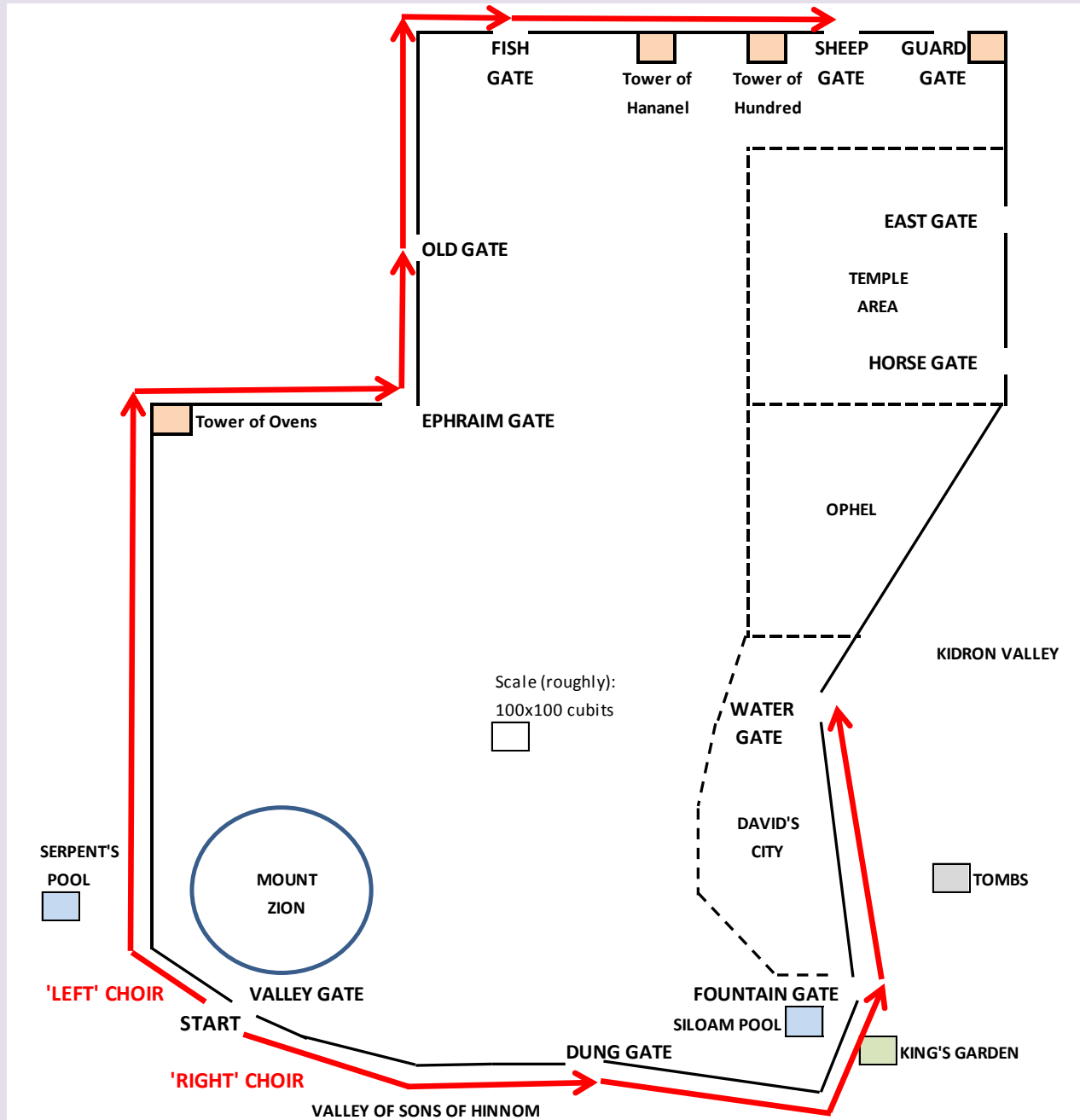

Nehemiah provides us with insights: (1) there are Two Choirs, two prophetic groups of 'wall walkers'; (2) the **Left Choir** are the Christians, whose home is **Mount Zion**, who look back in hope to the **Sheep Gate**; (3) the **Right Choir** led by Ezra the Scribe are the Jews, who look back to the promises made to the Patriarchs: rebuilding **David's City**, the inauguration of the Messiah, King of the World, Son of David, ruling from Jerusalem.

SUMMARY– BIG PICTURE

The Walls of Jerusalem predict modern history 1AD to the **Rapture**. The **Life of Christ** starts at the **Chamber of the Corner**: Christ leaves his lofty room (Heaven) to be incarnated in the lowly room (Womb) of Mary. In 9AD Christ appears in the Temple (**Sheep Gate**). On the final trip around, the **Chamber of the Corner** is the **Voice of the Archangel** (1st Seal) and the 1st Trumpet is the **Rapture of Saints**. From 2AD to 8AD is the **Great Tribulation**. Then at the very point on the Wall Christ 1st appeared in the Temple, 9AD, Christ's 2nd Coming!

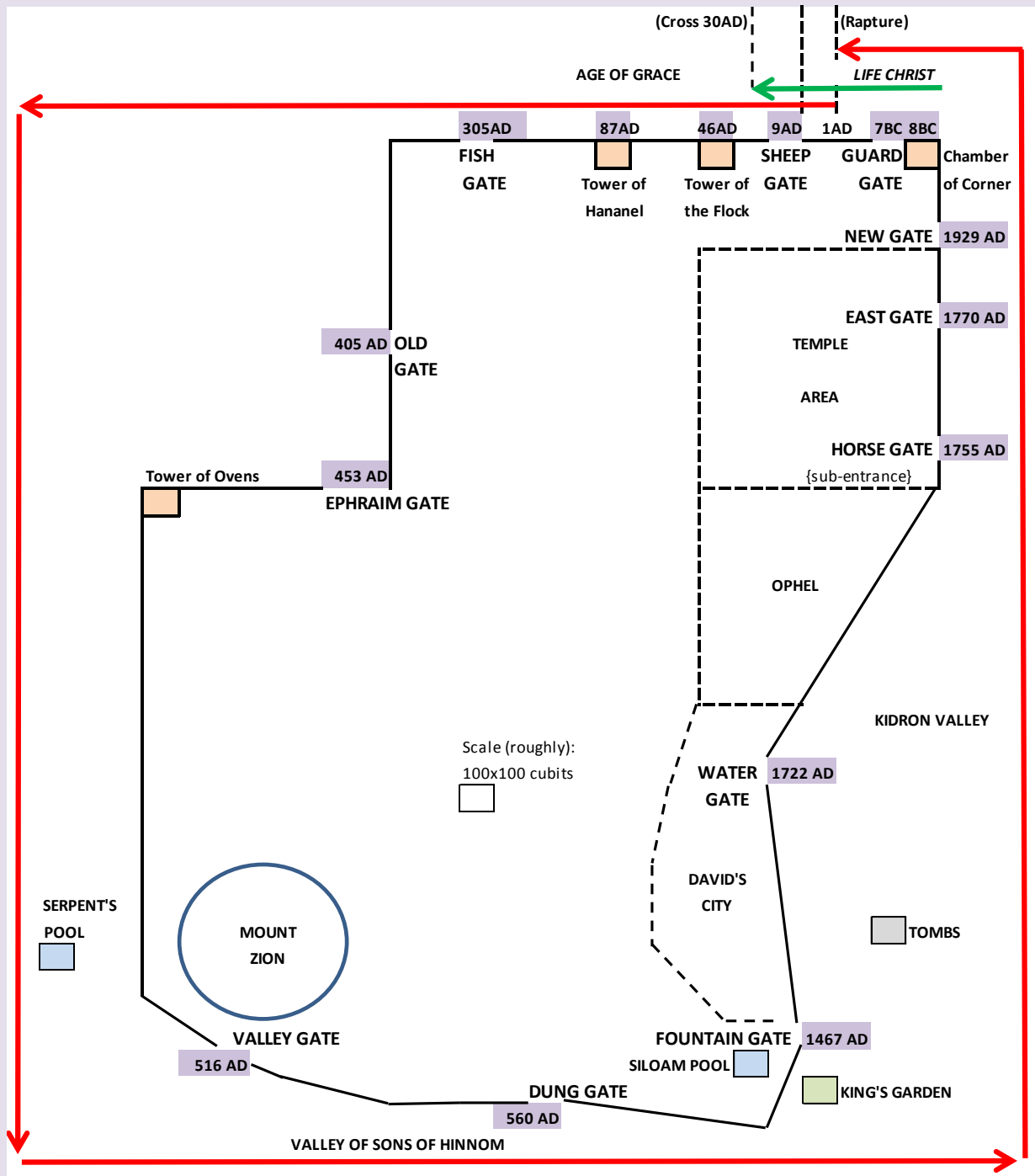

PART 1 – ROMAN EMPERORS RESIST GOD OF HEAVEN

Prophecy concerning the portion of the wall along the north wall directly west of the **Chamber of the Corner**:

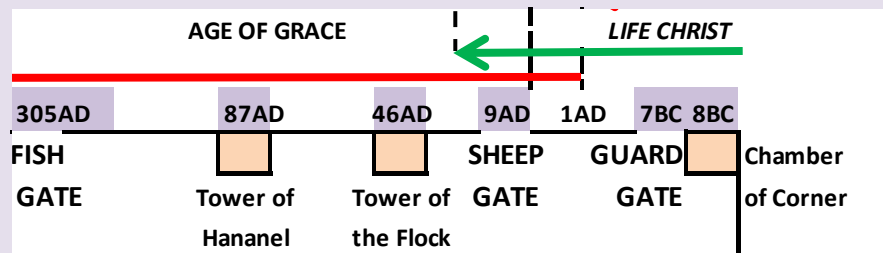

The following is the list of verses in the Prophets starting with **Songs 6:9** which contain the key-words: 'GATE' or 'TOWER'. **Isaiah 1:1** is **1 AD** so the **46th** verse of Isaiah, which is **Isaiah 2:15** corresponds to **46 AD**. Prophecy of modern history continues on a one-verse one-year basis through Isaiah and Jeremiah.

DATE	SCRIPTURE	TEXT	EVENT	NOTE
8 BC	Songs 6:9	My dove, my undefiled is but one; she is the only one of her mother, she is the choice one of her that bare her. The daughters saw her, and blessed her; queens ... praised her.	Annunciation to MARY	The CHAMBER OF THE CORNER does not speak only of Mary, it speaks of the lofty place of power that Jesus left to take the form of a child and be incarnated in lowly flesh.
7 BC	Songs 6:10	Who is this who appears like the dawn, fair as the moon, bright as the Sun, magnificent as stars in sky?	Birth of JESUS	Birth is the GATE from the womb into the world. At his birth a GUARD of heavenly angels appeared!
1 AD	Songs 7:4	Thy neck is as a tower of ivory; thine eyes like the fishpools in Heshbon, by the GATE of Bathrabbim: thy nose is as the tower of Lebanon	JESUS is in his 8th Year	Jesus, Himself, is THE GATE to God: "I am the way, the truth, and the life. No man comes to the Father but by me."
9 AD	Songs 7:12	Let us go early to the vineyards to see if the vines have budded, if their blossoms have opened, and if the pomegranates are in bloom - there I will give you my love.	JESUS appears in the Temple In his 16th Year, which was the 12th year He has been in the Holy Land after his return from Egypt (see Luke 2:41-42)	The SHEEP GATE . The sages test him to see if the vine has budded, i.e. Messiah has come, and the pomegranates are in bloom, he has special wisdom (fragrance).
46 AD	Isaiah 2:15	And upon every high TOWER , and upon every fenced wall,	ELYMAS , the Sorcerer, who opposed Paul and tried to turn the Roman Proconsul from the faith is blinded	ELYMAS is a type of the FALSE PROPHET . Some Jews practicing occult were whispering to power in Rome.
87 AD	Isaiah 5:2	And he fenced it, and gathered out the stones thereof, and planted it with the choicest vine, and built a TOWER in the midst of it, and also made a winepress therein: and he looked that it should bring forth grapes, and it brought wild grapes.	In 87 AD Emperor DOMITIAN executed several senators. His paranoia and murder extended to all. He commanded all the lineage of David be put to death. His reign of terror for Christians began in 81 AD.	DOMITIAN is a type of the ANTI-CHRIST . He asked to be addressed as ' <u>Lord and God</u> '. In 85 AD he had proclaimed himself ' <u>Perpetual Censor</u> ' granting himself near unlimited power. He worshipped the <u>Goddess Minerva</u> .
305 AD	Isaiah 14:31	Howl, O GATE ; cry, O city; thou, whole Palestina, art dissolved: for there shall come from the north a smoke, and none shall be alone in his	305 AD was the height of the GREAT PERSECUTION of Christians in the Roman Empire. Those who refused to sacrifice to pagan gods died.	The FISH GATE .

PART 2 – ROMAN EMPERORS TAUGHT TO FEAR THE LORD

Prophecy concerning the portion of the wall from the point it first turns south:

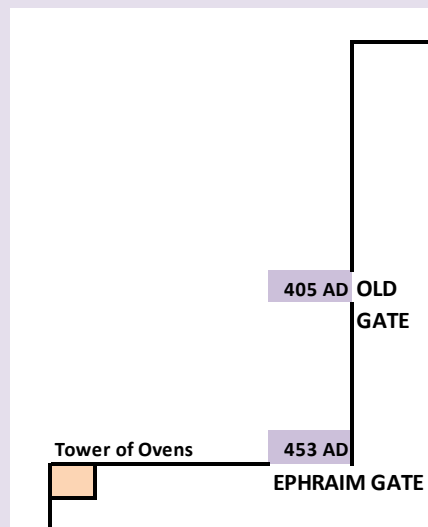

Verses in the Prophets (with the key-word 'GATE' highlighted) and corresponding dates in modern history:

DATE	SCRIPTURE	TEXT	EVENT	NOTE
313 AD	Isaiah 15:7	Therefore the abundance they have gotten, and that which they have laid up, shall they carry away to the brook of the willows	EDICT OF MILAN	Emperor CONSTANTINE , ends persecution of Christians. The old pagan ways will now seep into Christian Temples!
324 AD	Isaiah 16:9	I weep as Jazer weeps for the vines of Sibmah	Constantinople founded.	Same crap, different pile.
330 AD	Isaiah 17:1	Damascus will be no longer a city but ...ruins	Byzantium founded as 'New Rome'.	
373 AD	Isaiah 19:23	...a highway between Egypt and Assyria	Huns (from steppes) invade Danube	Vulnerable location.
381 AD	Isaiah 20:6	...how then can we escape?	Byzantium pays off Huns with gold.	Tempting target.
383 AD	Isaiah 21:2	...the traitor betrays, the looter takes loot	Roman Civil War. Magnus revolts.	Empire erodes at the fringes.
405 AD	Isaiah 22:7	...thy choicest valleys shall be full of chariots, and the horsemen shall array at the GATE .	Persian King YAZDAGERD adopts Theodosius II and raises the Christian emperor as his own son. This led to a long peace with Persia.	The OLD GATE
410 AD	Isaiah 22:12	that day weep and wail, tear out your hair...	Rome sacked by Visigoths (Alaric)	Alaric died the same year.
431 AD	Isaiah 23:8	Tyre, the bestower of crowns... [to goddesses]	Council of Ephesus [very bad!]	Cult of Mary: 'Mother of God'
443 AD	Isaiah 24:2	it will be the same for priest as for people...	Victory of Huns over Byzantium	Huge tribute paid to the Huns
453 AD	Isaiah 24:12	In the city is desolation, and the GATE is smitten with destruction.	Attila the Hun dies. Like the Huns the idol worshiping Kings of Israel attacked Jerusalem. Likewise they perished. And peace was restored.	The EPHRAIM GATE
475 AD	Isaiah 25:11	God will bring down their pride...	Nepos, Roman Emperor flees Italy	Rome revolts.
476 AD	Isaiah 25:12	He will bring down their high fortified walls..	Odacer forbids Nepos to return	Roman Emperor has no army.
477 AD	Isaiah 26:1	A song in Judah: we have a strong city...	Last Roman Emperor.	The LORD! He is God!

The **Tower of Ovens** [bakeries?] existed in Nehemiah (3:11). A **High Tower** of faith is implied (see Isaiah 26:3).

THE DARK AGES OF HISTORY

Prophecy concerning Islam in Africa and Middle East:

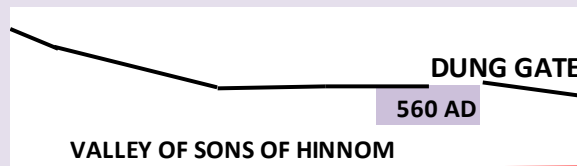

Verses in the Prophets (with the key-word 'GATE' highlighted) and corresponding dates in modern history:

PART 4 - ISLAM CONSUMES THE NATIONS LIKE LOCUSTS

DATE	SCRIPTURE	TEXT	EVENT	NOTE
548 AD	Isaiah 29:9	Be drunk, but not from wine, stagger...	Theodora dies	
556 AD	Isaiah 29:18	Lebanon will be a fertile field	Khadijah is born	First cousin twice removed fr. Moh.
560 AD	Isaiah 29:21	with a word make a man guilty, who ensnare the defender in the GATE and with false testimony.. deprive the innocent of justice.	Waraka ibn Nawfal, Nestorian priest, cousin of Khadijah, preaches monotheism in Mecca	The DUNG GATE . Nestorians were rejected by Church Councils, Meccan polytheists, and Islam.
561 AD	Isaiah 29:22	No longer will Jacob be ashamed...	Persia defeats Byzantium	
569 AD	Isaiah 30:6	envoys carry... treasures on the humps of camels to that unprofitable nation	Mohammed is born	He will unite all the tribes of Arabia into one confederation.
605 AD	Isaiah 31:9	Their stronghold will fall because of terror	Mohammed places the Black Stone	Ka'aba was being re-constructed
614 AD	Isaiah 32:9	You complacent women listen to me	Meccans invited to join Islam	But they reject Mohammed
622 AD	Isaiah 32:17	The fruit of righteousness will be peace...	The Hirja: Migration to Medina	The first Islamic State declared
632 AD	Isaiah 33:7	Look their brave men cry in the streets...	Caliph Mohammed dies	Green dome mosque... his tomb
661 AD	Isaiah 34:12	...all her princes will vanish away	Caliph Ali stabbed with poison, dies	While praying in a mosque...
663 AD	Isaiah 34:14	Desert creatures will meet with hyenas... and wild goats will bleat to each other	Ummayad Dynasty ruling Islam - capital in Damascus, Syria	Mostly Christian civilians of Syria treated peacefully
674 AD	Isaiah 35:8	A highway will be there: the Way of Holiness... wicked fools will not go on it	First siege of Constantinople attempted by the Moslems.	The walls of Constantinople hold, the siege fails after years of effort
680 AD	Isaiah 36:4	Tell Hezekiah, this is what the King says..	Battle of Karbala: Moslem Civil War	Hussein bin Ali beheaded, dies
692 AD	Isaiah 36:16	Do not listen to Hezekiah... the King says...	Dome of the Rock built	Jerusalem becomes a Moslem city
718 AD	Isaiah 37:20	O Lord our God deliver us from his hands...	Second siege of Constantinople	Also unsuccessful
732 AD	Isaiah 37:34	By the way he came he will return...	Moslems defeated: Battle of Tours	Charles Martel forever famous
717 AD	Isaiah 38:1	In those days Hezekiah became ill...	Moslems defeated: Battle Avignon	
742 AD	Isaiah 38:6	I will deliver this city from King of Assyria	Charlesmagne is born	
744 AD	Isaiah 38:8	I will make the shadow of the Sun go back	Third Moslem Civil War	
750 AD	Isaiah 38:14	I moaned like a morning dove...	Battle of Zab	Entire Ummayad family massacred

Do Moslems have spiritual access to Jerusalem? They were offered the testimony of the Nestorian missionary **Waraka**. Islamic tradition says **Waraka** predicted **Mohamed** would be 'a prophet to these people' and bring 'a law like Moses'. But **Mohamed** rejected **Waraka** and prayed to Allah, a local Arab deity, patron of Mecca.

Moslems deny a Savior Messiah comes from the Jews. So, Moslems put themselves outside the walls of the **Jerusalem** into the **Valley of the Sons of Hinnom**. Consistent with this, Moslems pray to the Mecca sanctuary. Confusingly, Moslems deny Jesus was crucified; they say he ascended and will return in a Last Battle on earth.

PART 5 – CHRISTIAN RELIGION REVIVES IN EUROPE

In the darkest hours of attacks by Vikings and Moslems a religious fire is kindled in Europe and spreads.

DATE	SCRIPTURE	TEXT	EVENT	NOTE
768 AD	Isaiah 40:2	Speak tenderly to Jerusalem... sin is paid	Charlemagne king of the Franks	< CORNER IN THE WALL >
780 AD	Isaiah 40:14	Who was it who taught him knowledge?	Charlemagne assists mass baptism	Joy in Saxony
782 AD	Isaiah 40:16	Lebanon is not enough for altar fires...	Massacre of pagans at Verden	Charlemagne says: 'convert or die'
797 AD	Isaiah 40:31	Those who hope in the Lord renew strength	Moslem Barcelona falls to Franks	Barcelona was a great city
800 AD	Isaiah 41:3	He moves... on a path he has not travelled	Charlemagne crowned in Rome..	'Emperor of the Romans' by Pope.
820 AD	Isaiah 41:23	Tell the future so we may know you as gods	Angsar, missionary to Denmark	Unsuccessful: left after 2 years
829 AD	Isaiah 42:3	A bruised reed he will not break...	Angsar, missionary to Sweden	Successful: church planted
864 AD	Isaiah 43:13	Yes from ancient days I AM he... my hand	Tsar Boris of Bulgaria baptised	By Byzantine clergy
865 AD	Isaiah 43:14	I will send... Babylonians in ships...	Great Heathen invasion of England	Danish vikings arrive in ships
878 AD	Isaiah 43:27	Yr first father sinned... rebeled against me	Battle of Edington: Vikings defeated	Danish king & 29 nobles baptised
881 AD	Isaiah 44:3	I will pour water on a thirsty land...	Alfred sends alms to Rome for poor	
897 AD	Isaiah 44:18	They know nothing, they understand not..	Second Viking invasion defeated	England embraces Church of Rome

Looking at the geography we see no **Towers** and no **Gates of Jerusalem** in this span of the wall. At first blush it looks like Christianity is reviving but in fact Christian religion is reviving. Not the same thing.

Emperor Charlemagne was a beast who lived in a wild forest. He developed his taste for Christian religion in perilous times. The Church in Rome eagerly wed herself back to an emperor protector. The result was the spread of Christian religion by the force of the sword. This abused the commands of our Savior Jesus Christ.

Nevertheless, the Christian Kingdoms assented to the Incarnation: they are not spiritually **Sons of Hinnom**.

PART 6 – ISLAMIC CALIPHATE DIVIDES

Islam divides into **Sunni Caliphates**, based in the Middle East, and **Shia Caliphates**, based in Africa. Although considered the Golden Age of Islam, the Christian religion is expanding east into Bulgaria and Poland too.

DATE	SCRIPTURE	TEXT	EVENT	NOTE
908 AD	Isaiah 45:1	This is what the Lord says to Cyrus...	Al-Mahdi founds Fatimid Empire	A Shia Caliph [later emerges in Iran!]
921 AD	Isaiah 45:14	Egypt, Cush, Sabeans will come over to you	Capital of Fatimids set in Tunisia	Fatimid Empire was North Africa!
933 AD	Isaiah 46:1	Bel bows down, Nebo stoops low	Buyids encroach on Abbasids	Abbasid Caliphate based in Baghdad!
934 AD	Isaiah 46:2	...they go off into captivity	Buyids conquer Shiraz	Shiraz becomes capital of Buyyids
945 AD	Isaiah 46:13	I am bringing my righteousness near...	Abbasid Caliph vassal to Buyids	Buyyids revive Persian titles, ways
966 AD	Isaiah 46:6	I will tell you of hidden things long ago	Ruler of Poland baptised	People of Poland stayed pagans
969 AD	Isaiah 48:9	For my own name's sake I delay my wrath	Fatimids conquer Egypt	Move capital to Cairo
987 AD	Isaiah 49:5	He formed me in the womb, his servant	Prince Vladamir converts	Russia is Christian ever since
988 AD	Isaiah 49:6	... to restore the tribes of Jacob	Mass baptism of Kievians	And prince Vladamir
1016 AD	Isaiah 50:8	Who is my accuser? Let us face each other!	Birth of Tughril Beg	Founder Seljuk Empire
1036 AD	Isaiah 51:17	Arise you who have drunk the cup of wrath	Turkish Eurasian tribes unite	Inception of Seljuk Empire
1037 AD	Isaiah 51:18	Of all her born sons there was none to lead	Birth of Saladin, a Kurd	Who would lead Arab armies...

The Moslem Caliphates based in Turkey will be a thorn in the side of Christian Europe for nine hundred years.

PART 7 – NORMAN KING CONQUERS ENGLAND, NORMAN KNIGHTS CONQUER JERUSALEM

The sons of **King Canute** are defeated by **William the Conqueror**. Norman nobility, a mix of French nobility and **Viking** chiefs replaced Anglo-Saxon families. A Norman clergy, loyal to William not Rome, swept in.

The first **Crusader** army composed of French and Norman Knights is led by **Godfrey of Bouillon**. The **Crusaders** enter Jerusalem and massacre the civilians. Crusaders were not Christians: but pillaging **Vikings!**

DATE	SCRIPTURE	TEXT	EVENT	NOTE
1042 AD	Isaiah 53:23	cup of my wrath to hands of your enemies	Edward the Confessor crowned	Peace comes to England
1053 AD	Isaiah 52:11	Depart! Depart! Go out from there!	Pope Leo leads troops in battle.	Man of Blood: cannot be a priest.
1054 AD	Isaiah 52:12	But you will not leave in haste...	The Great Schism: East vs West	Roman Church vs Orthodox Church
1066 AD	Isaiah 53:9	...he had done no violence nor any deceit	Edward the Confessor dies	Without an heir. Hence the war.
1066 AD	Isaiah 53:9	He was assigned a grave with the wicked...	Battle of Hastings: Harold dies	William the Conqueror rules England
1067 AD	Isaiah 53:10	Yet it was the Lord's will to crush him	Earles of England lose lands, titles	Normans nobles occupy all posts
1070 AD	Isaiah 54:1	more the children of the desolate woman	English Bishops, Abbots retired	Norman clergy occupy church posts
1095 AD	Isaiah 55:9	my thoughts are higher than your thoughts	Pope Urban launches 1st crusade	to defend Byzantium? [a cover story]
1098 AD	Isaiah 55:12	all the trees of the field will clap th. Hands	Antioch falls to the Crusaders	Massacre of inhabitants. Clap='bad!'
1099 AD	Isaiah 55:13	Instead of the thornbush, grows pine tree...	Jerusalem captured by Crusaders	...provokes revival of militant Islam
1104 AD	Isaiah 56:5	within my temple I will give them a name	Acre is captured	
1110 AD	Isaiah 56:11	they are dogs with mighty appetites	Beruit is captured	
1111 AD	Isaiah 56:12	let's get wine! Tomorrow will be like today	Sidon is captured	

PART 8 – BERNARD OF CLAIRVAUX LAUNCHES 2ND CRUSADE: SALADIN MAKES JERUSALEM A CITY OF PEACE

Church 'Holy' Orders sanction **Mary Worship**. Moslems triumph in battle. Knights Templar setbacks.

DATE	SCRIPTURE	TEXT	EVENT	NOTE
1112 AD	Isaiah 57:1	The righteous perish and no one ponders it	Cistercian Order founded	Worships Mary as 'Intercessor'
1115 AD	Isaiah 57:5	Are you not a brood of rebels, sons of liars?	Clairvaux monastery founded	By Bernard of Clairvaux
1128 AD	Isaiah 57:15	I was enraged by his sinful greed...	Orders drafted for Knights Templar	By Bernard of Clairvaux
1129 AD	Isaiah 57:18	I will heal him; I will guide him...	K.Templar sanctioned by C. Church	1st Cist. Abbey in Bavaria
1130 AD	Isaiah 57:19	Peace, peace... I will heal them	Schism in Catholic Church	Bernard to choose new Pope
1132 AD	Isaiah 57:21	There is no peace' says God 'for the wicked'	Over 1,000 Cistercian houses	All over Europe
1145 AD	Isaiah 58:13	If you keep your feet fr. breaking Sabbath	2nd Crusade launched	By Bernard of Clairvaux
1147 AD	Isaiah 59:1	Surely the Arm of the Lord is not too short?	2nd Crusade a failure	
1155 AD	Isaiah 59:9	We look for light but walk in deep shadows	Frederick I crowned.	Holy Roman Emperor
1174 AD	Isaiah 60:7	All of Kedar's flocks will be gathered to you	Moslems attacks Crusader Syria	By Saladin
1182 AD	Isaiah 60:13	I will make you the joy of all generations	Moslems conquers Crusader Syria	By Saladin
1187 AD	Isaiah 60:20	Your Sun will never set nor Moon wane	Moslems win the Battle of Hattin	By Saladin
1188 AD	Isaiah 60:21	They are the shoot I have planted...	'Cutting of the Elm Tree'	Knights Templar split: R. Cross?
1190 AD	Isaiah 61:1	the LORD has annointed me	Order of Teutonic Knights founded	Grand Master: Prince of Prussia
1191 AD	Isaiah 61:2	proclaim... the vengeance of our God	Acre, Jaffa captured	By Saladin
1192 AD	Isaiah 61:3	and provide for those who grieve in Zion	Treaty: Pilgrims may enter Jerusal.	By Saladin
1193 AD	Isaiah 61:4	They will rebuild the ancient ruins	Richard Lionheart ransomed	Let loose from castle prison
1195 AD	Isaiah 61:6	And you will be called priest of the LORD	Richard's land dispute with France	Resolved: declared Church land
1196 AD	Isaiah 61:7	Instead of shame my people double share	Richard starts building a castle...	...on land belonging to Church
1199 AD	Isaiah 61:10	He... arrayed me in a robe of righteousness	Richard shot in neck with an arrow	Blood flows onto his robe...

PART 9 – ST. FRANCIS PREACHES REPENTANCE IN WEST, MONGOLS PUNISH SINNERS IN EAST

The Mongols, monotheists, worshiped 'Sky God'. They purged China of polytheism and star worship. The Mongols honored Christ. Why? Because of the testimony of Nestorian priests in their court! The **Dung Gate!**

DATE	SCRIPTURE	TEXT	EVENT	NOTE
1204 AD	Isaiah 62:4	for the LORD will take delight in you	St. Francis has a vision, leaves war	Joins beggars at St. Peter's
1205 AD	Isaiah 62:5	... so your sons will marry you	St. Francis preaches in the streets	gathers followers
1206 AD	Isaiah 62:6	you who call on LORD give y/self no rest	Ghengis Khan rules Mongolia	Subdues all Mongol clans
1210 AD	Isaiah 62:10	Pass through gates... remove the stones...	Pope authorizes Franciscan Order	Breath of air in Roman Church
1211 AD	Isaiah 62:11	Say to Daughter of Zion, your Savior comes!	Emperor Xia submits to G. Khan	Conquest of China begins
1215 AD	Isaiah 63:3	I trampled them in my anger...	Ghengis Khan sacks Capital of Jin	Beijing falls to Mongols
1218 AD	Isaiah 63:6	I trampled the nations in my anger...	Mongolians reach border Moslems	Mongols regroup and rest
1220 AD	Isaiah 63:8	Surely they are my people... not false to me	Caravan of peace sent to Moslems	"Let us conclude a treaty..."
1221 AD	Isaiah 63:9	In all their distress he too was distressed	Caravan of peace looted	
1222 AD	Isaiah 63:10	So he turned and became their enemy	Ambassadors sent back to G.Khan	One head sent back in basket
1223 AD	Isaiah 63:11	Then his people recalled the days of old	St. Francis arranges a nativity scene	1st ever
1225 AD	Isaiah 63:13	like a horse in the open.. does not stumble	Mongol Hordes	
1221 AD	Isaiah 63:15	Tenderness and compassion are withheld	Capital of Shah falls to Mongols	Enormous massacre
1231 AD	Isaiah 63:19	We are yours from of old...	Mongols invade Korea	
1232 AD	Isaiah 64:1	O you come down... mountains tremble	South China falls to Mongols	
1236 AD	Isaiah 64:5	You were angry... how can we be saved?	Mongols invade Rus	Russian steppes
1241 AD	Isaiah 64:10	Even Zion is a desert, Jerusalem devastated	Mongols invade Poland, Hungary	
1242 AD	Isaiah 64:11	Our holy and glorious temple... burned	Mongols invade Serbia, Bulgaria	
1243 AD	Isaiah 64:12	Will you punish us beyond measure?	Mongols invade Anatolia	

PART 10 – MONGOLS MAKE PEACE WITH CHRISTIANS, LATER CONVERT TO ISLAM, GOD PUNISHES THEM

From the day the first Mongol Khan accepts Islam, their empire suffers repeated defeats. After one last push to conquer pagan Burma, the Mongol empire is in retreat and loses all possessions: back to herding sheep.

DATE	SCRIPTURE	TEXT	EVENT	NOTE
1257 AD	Isaiah 65:14	... but you will cry from anguish of heart	Mongols invade Vietnam	Hanoi put to sword
1258 AD	Isaiah 65:15	... the Sovereign Lord will put you to death	Mongols invade Moslem lands	Baghdad put to sword
1260 AD	Isaiah 65:17	I create a new heavens and a new earth	Mongols invade Moslem Syria	Conquest stops here
1262 AD	Isaiah 65:19	I will rejoice over Jerusalem... no weeping	Mongols offer peace to King France	Promise restoration of Jerusalem
1264 AD	Isaiah 65:14	They will plant vineyards and eat fruit	Mongols invade Byzantium	Byzantium flees
1265 AD	Isaiah 65:15	No longer will they plant & others eat	Mongols make treaty w. Byzantium	Peace in exchange for fabrics
1268 AD	Isaiah 65:25	The wolf and the lamb will feed together	Mongols and Christian West friends	Exchange letters
1269 AD	Isaiah 66:1	Where is the house you will build for me?	Mongols send aid to Edward	Moslems are cornered now
1270 AD	Isaiah 66:2	The one I esteem.. trembles at my word	Korea makes peace with Mongols	Royalty inter-marries Mongols
1273 AD	Isaiah 66:3	Your brothers... will be put to shame	Mongols invade Japan	Japan hates Korea forever
1274 AD	Isaiah 66:6	Hear the uproar... noise from the temple	Russian princes vassals of Mongols	Rome sends ambassadors to Mongols
1277 AD	Isaiah 66:9	Do I bring to birth and not deliver?	Mongols invade Burma	Not successful, 1st time
1282 AD	Isaiah 66:14	... LORD's fury will be shown to his foes	Moslem Khan converts to Islam	Offers alliance to Mamluk Sultan
1283 AD	Isaiah 66:15	the Lord is coming with fire	Mongols invade Burma	Not successful, 2nd time
1284 AD	Isaiah 66:16	... many will be those slain by LORD	Mongols invade Hungary	Defeated, many Mongols die
1287 AD	Isaiah 66:19	distant islands will hear of my fame	Mongols invade Burma	Crush the last Asian pagan Nation

APPENDIX: INTERPRETTING THE PROPHETS

The Prophets do not have only a single interpretation, but multiple fulfillments. Like gems, light can strike from many angles to produce a sparkle. Here, we look at what the Prophets say regarding modern history.

For this purpose we recognize some principles of Prophecy interpretation:

- “LORD”** Can mean ‘JEHOVAH’ (who is Jesus) in the highest Heaven ruling over all nations and peoples;
Can mean ‘SUPREME RULER’ who has authority over a confederation of nations and peoples;
- “JUDAH”** Can mean the community of Jews – who observe traditional customs of the people of Judah;
Can mean a community of Ultra-Religious People – who observe traditions but have no faith;
E.g. in the Prophets God speaks of Roman Church as “JUDAH” – V. religious but no saving faith;
- “ISRAEL”** Nations in the West whose national religion was at one time the worship of Jehovah (Jesus);
Tribes of Israel are prophetic of nations in modern history (e.g. Britain = Manasseh);
- “BABYLON”** A nation with some religious possessions (e.g. articles stolen from Temple of Jehovah);
A nation that has never officially honored Jehovah (who is Jesus) above all gods;
Babylon can be: Sultanates / Caliphates / Khanates; America (officially deist); Vikings; etc;
- “ASSYRIA”** A nation with some spiritual heritage (i.e. at one time Assyria repented at preaching of Jonah)
Always a ruthless and merciless Sword of the Lord, wreaking destruction on neighbors;
- “EGYPT”** A nation with a cultic ruler that is filled with “IDOLS” (see definition in this list);
A nation that persecutes its own people; enslaving them and grinding them to dust;
- “TYRE”** A nation that harbors international commercial traders (i.e. merchants of the sea)
They worship a harlot goddess (i.e. they trade with anyone). Tyre is in alliance with the Devil.
- “IDOLS”** Humans who are venerated as having power or knowledge or purity from sin like the gods;
E.g.: Pope to Catholics / Orthodox; national heroes (e.g. Lenin, Washington, Ali, Osman);
A human with loyal ‘fans’: sports stars, movie stars, pastors and priests over congregations;
- “DAUGHTER”** Always a religious community; usually having the religious heritage of a foster nation;

Example: 'Daughter of Babylon' in a certain context might be Moslem believers;

- "ZION"** Mount Zion is a hill in south-west Jerusalem with no temples; Zion is Faith in a Savior Messiah;
- "EPHRAIM"** Can mean "ISRAEL" since the tribe of Ephraim was the lead tribe of the northern Kingdom
But, after 1776 AD, "EPHRAIM" is fulfilled as the United States of America
- "BENJAMIN"** Means "JEWISH HOMELAND IN PALESTINE". After 1917 it is "MODERN STATE OF ISRAEL" (sic)
Prior to 1917, "BENJAMIN" means the people who long for a Jewish Homeland in Palestine.
- "TEMPLE"** Means 'Man-made Religion'; Like Solomon's Temple – all measurements out of a man's mind;
- "PRIEST"** Means 'Highest Authority in the Temple'; i.e. most senior figure in a Man-Made Religion
Man-Made Religion includes the secret cults: Knights Templar, Freemasonry, Bensaalem, etc.
Since the British Monarch is also head of the Church of England: he is a prophetic "PRIEST"
- "PROPHET"** Means 'One Who Speaks God's Will' regarding issues outside boundaries of Man-Made Religion
E.g. In Jeremiah, Parliaments are spoken of as "PROPHETS"; prophets may be good or bad;
- "KING"** Means 'Highest Authority in the State'; usually applies to a monarchy or a dictatorship;
Can mean religious leaders, like the Pope, who are also the head of a state: i.e. the Vatican;
- "JERUSALEM"** Community of all people who believe the Savior Messiah must be a literal Son of David;
Geographically, Jerusalem is outside Judah; Jerusalem does not belong to the Jews!
Of the Jews, some will pilgrimage to Jerusalem (i.e. worship the Savior Messiah); others won't.
All born-again Christians belong to 'the Jerusalem that is above' (worship the Savior Messiah)
Those who worship Savior Messiah at Mount Zion gain favor with God by faith in Jesus' blood;
Those who worship at a Temple in Jerusalem gain no favor with God: they deny Jesus' blood;
IMPORTANT INSIGHT: Jerusalem has enemies within and without the Walls;
Enemies Outside: Nations who despise the Savior Messiah (pagan and post-Christian nations)
Enemies Inside: Sects who reject salvation by faith in the Savior Messiah (all legalistic religions)
- "GATE"** An entrance to Jerusalem that is often the focus of battle with enemies, inside and outside.